

ICOM

INSTRUCTION MANUAL

SSB RADIO TELEPHONE
IC-M700PRO



Icom Inc.

IMPORTANT

READ THIS INSTRUCTION MANUAL CAREFULLY before attempting to operate the transceiver.

SAVE THIS INSTRUCTION MANUAL—This manual contains important safety and operating instructions for the IC-M700PRO SSB RADIO TELEPHONE.

EXPLICIT DEFINITIONS

The explicit definitions described below apply to this instruction manual.

WORD	DEFINITION
⚠ WARNING	Personal injury, fire hazard or electric shock may occur.
CAUTION	Equipment damage may occur.
NOTE	If disregarded, inconvenience only. No risk of personal injury, fire or electric shock.

PRECAUTIONS

⚠ WARNING! NEVER connect the transceiver to an AC outlet directly. This may pose a fire hazard or result in an electric shock.

⚠ WARNING! NEVER mount the transceiver overhead. The weight of the transceiver is approximately 8 kg., but its apparent weight will increase several fold due to wave shocks and vibration. The transceiver must be mounted on a flat hard surface only.

NEVER connect a power source of more than 16 V DC such as a 24 volt battery. This connection will ruin the transceiver.

NEVER allow children to play with equipment containing a radio transmitter.

NEVER expose the transceiver to rain, snow or any liquids.

NEVER install the IC-M700PRO into a plus-grounding ship. Such a connection might blow fuses and is not usable.

DO NOT use chemical agents such as benzene or alcohol when cleaning, as they can damage the transceiver's surfaces.

In maritime mobile operation, **KEEP** the transceiver and microphone as far away as possible (at least 1 m) from the magnetic navigation compass to prevent erroneous indications.

USE an Icom microphone and/or handset only (supplied or optional). Other brands may have different pin assignments and may damage the transceiver.

AVOID using or placing the transceiver in areas with temperatures below -20°C (-4°F) or above $+60^{\circ}\text{C}$ ($+140^{\circ}\text{F}$).

AVOID connecting the transceiver to a power source using reverse polarity. This connection will not only blow fuses but may also damage the transceiver.

AVOID placing the transceiver in excessively dusty environments or in direct sunlight.

AVOID placing the transceiver against walls or putting anything on top of the transceiver. This will obstruct heat dissipation.

IN CASE OF EMERGENCY (for maritime operation)

If your vessel requires assistance, contact other vessels and the Coast Guard by sending a distress call on 2182 kHz.

- | | |
|--|--|
| ① Push [2182kHz] to select the emergency frequency. | 1. "MAYDAY, MAYDAY, MAYDAY" |
| ② Push [ALARM] and [TX.FREQ] for 1 sec. to transmit a 2-tone alarm signal for at least 30 sec. <ul style="list-style-type: none">• The transceiver automatically stops the alarm after 50 sec. | 2. "THIS IS " (name of vessel) |
| ③ Push [ALARM] to turn the alarm transmission off, then push and hold the PTT switch on the microphone and send the following information: | 3. "LOCATED AT " (vessel's position) |
| | 4. Give the reason for the distress call. |
| | 5. Explain what assistance you need. |
| | 6. Give additional information: <ul style="list-style-type: none">• Vessel type• Vessel length• Vessel color• Number of people onboard. |

VERSIONS

The following versions are available for the IC-M700PRO.

Version	Description
Marine	2182 kHz 2-tone alarm is built-in. FSK/CW narrow filter is optional. All SSB/FSK channels available.
General	2182 kHz 2-tone alarm is optional. No transmit frequency programming allowed.

TABLE OF CONTENTS

IMPORTANT	ii	5 SET MODE	11-14
EXPLICIT DEFINITIONS	ii	■ Set mode operation	11
PRECAUTIONS	ii	■ Set mode contents	11
IN CASE OF EMERGENCY	iii	6 CONNECTIONS AND INSTALLATION	15-21
VERSIONS	iii	■ Connections on rear panel	15
TABLE OF CONTENTS	iv	■ Unpacking	15
1 OPERATING RULES AND GUIDELINES	1	■ Connector information	16
2 PANEL DESCRIPTION	2-4	■ Ground connection	18
■ Front panel	2	■ Power source	18
■ Display	4	■ Antenna	19
3 SELECTING A CHANNEL/FREQUENCY	5-7	◇ MN-100/MN-101L	19
■ Memory mode/VFO mode	5	◇ AT-130	19
■ Selecting a channel	5	◇ Non-Icom tuner	19
◇ Scan function	6	■ Mounting	20
■ Selecting a frequency	6	◇ Mounting location	20
■ Resetting the CPU	7	◇ Mounting example	20
4 RECEIVE AND TRANSMIT	8-10	◇ Transceiver dimensions	20
■ Basic voice receive and transmit	8	■ Installing internal options	21
■ Functions for transmit	8	◇ Opening the case	21
◇ Transmit frequency check	8	◇ Installing an optional filter and alarm unit	21
■ Functions for receive	9	■ Fuse replacement	21
◇ Squelch function	9	7 TROUBLESHOOTING	22
◇ Noise blanker	9	8 SPECIFICATIONS AND OPTIONS	23
◇ AGC off function	9	■ Specifications	23
◇ Clarity control	9	■ Options	23
■ CW operation	10		
■ FSK operation	10		

□ CALL PROCEDURES

Calls must be properly identified and time limits must be respected.

- ① Give your call sign each time you call another vessel or coast station. If you have no call sign, identify your vessel name and the name of the licensee.
- ② Give your call sign at the end of each transmission that lasts more than 3 min.
- ③ You must break and give your call sign at least once every 15 min. during long ship-to-shore calls.
- ④ Keep your unanswered calls short, less than 30 sec. Do not repeat a call for 2 min.
- ⑤ Unnecessary transmissions are not allowed.

□ PRIORITIES

- ① Read all rules and regulations pertaining to priorities and keep an up-to-date copy handy. Safety and distress calls take priority over all others.
- ② False or fraudulent distress calls are prohibited and punishable by law.

□ PRIVACY

- ① Information overheard but not intended for you cannot be lawfully used in any way.
- ② Indecent or profane language is prohibited.

□ LOGS

- ① All distress, emergency and safety calls must be recorded in complete detail. Log data activity is usually recorded in 24 hour time. Universal Time (UTC) is frequently used.
- ② Adjustments, repairs, channel frequency changes and authorized modifications affecting electrical operation of the equipment must be kept in the maintenance log; entries must be signed by the authorized licensed technician performing or supervising the work.

□ RADIO LICENSES

(1) SHIP STATION LICENSE

You must have a current radio station license before using the transceiver. It is unlawful to operate a ship station which is not licensed.

Inquire through your dealer or the appropriate government agency for a Ship-Radiotelephone license application. This government-issued license states the call sign which is your craft's identification for radio purposes.

(2) OPERATOR'S LICENSE

A Restricted Radiotelephone Operator Permit is the license most often held by small vessel radio operators when a radio is not required for safety purposes.

The Restricted Radiotelephone Operator Permit must be posted or be kept with the operator. Only a licensed radio operator may operate a transceiver.

However, non-licensed individuals may talk over a transceiver if a licensed operator starts, supervises, and ends the call, and makes the necessary log entries.

Keep a copy of the current government rules and regulations handy.

■ Front panel

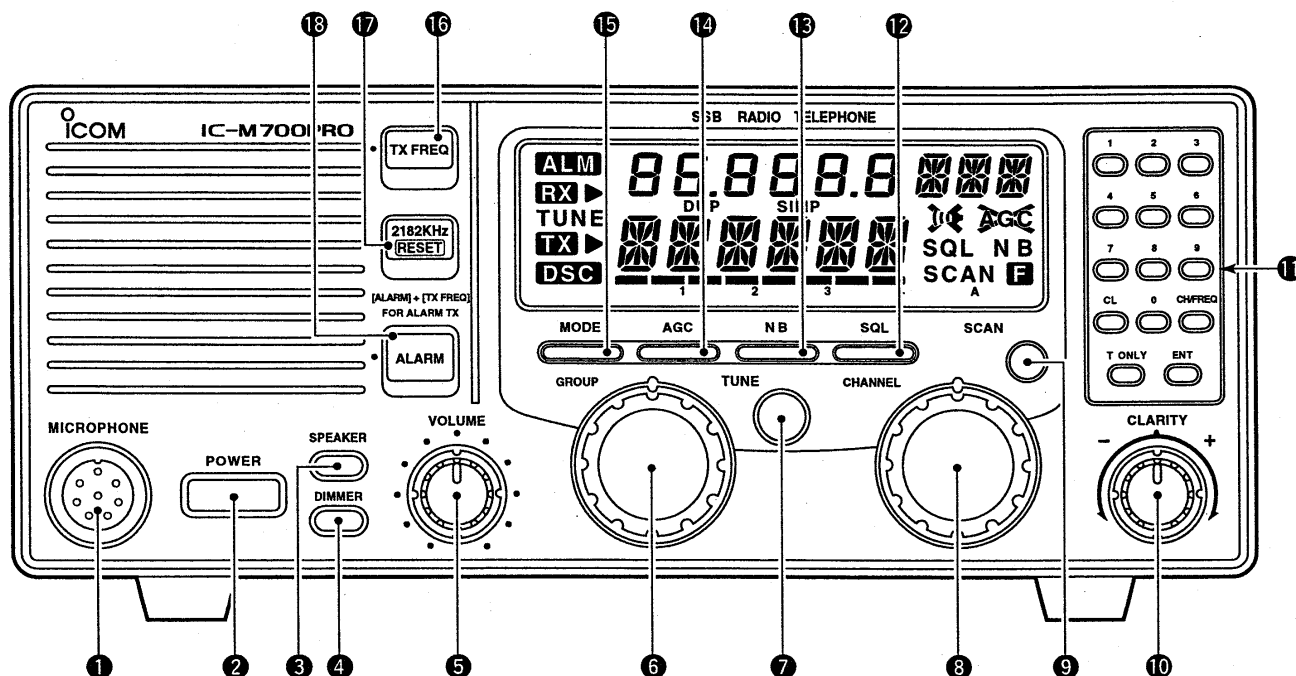

1 MICROPHONE CONNECTOR (p. 16)

Accepts the supplied microphone or an optional handset.

NOTE: No audio is output via the speaker when the microphone or handset is not connected.

2 POWER SWITCH [POWER]

Turns power on and off.

3 SPEAKER SWITCH [SPEAKER]

Turns the built-in speaker on and off.

- "S" appears in the display while the speaker is turned off.
- Any external speaker connected to the rear panel is not turned off.

4 DISPLAY INTENSITY SWITCH [DIMMER]

Turns the display backlighting on and off.

5 VOLUME CONTROL [VOLUME]

Adjusts the audio output level.

- Audio does not come from the speaker when:
 - A microphone is not connected.
 - The [SQL] switch is turned on and no signal is being received.

6 GROUP CHANNEL SELECTOR [GROUP]

- In memory mode, selects 1 of 3 channel groups ("A," "B" or "C"). (p. 5)
 - In VFO mode, no function.
- Selects an item in set mode. (p. 11)

7 ANTENNA TUNE SWITCH [TUNE] (p. 8)

Tunes the connected tuner to the antenna.

- Activates only when an optional antenna tuner such as Icom's AT-130 is connected.

NOTE: When selecting "automatic tuning" in set mode, pushing this switch is not necessary to tune the antenna. (p. 11)

8 CHANNEL SELECTOR [CHANNEL] (p. 5)

- In memory mode, selects an operating channel within the selected channel group.
 - A maximum of 50 channels are available in each channel group depending on set mode setting (pgs. 13, 14).
- In VFO mode, changes the operating frequency in 0.1 kHz steps.
 - Frequencies selected in VFO mode are temporary.

9 SCAN SWITCH [SCAN] (p. 6)

Push to toggle scan on and off.

10 CLARITY CONTROL [CLARITY] (p. 9)

Shifts the receive frequency ± 150 Hz for clear reception of an off frequency signal.

11 KEYPAD

CL No function*.



CH/FREQ Toggles between memory mode and VFO mode. (p. 5)



- This key may be disabled by your dealer.

T ONLY No function*.



ENT No function*.



0 No function*.



to



12 SQUELCH SWITCH [SQL] (p. 9)

Activates the voice squelch function to reject undesired background noise while no signal is being received.

- The squelch opens only when the received signal contains no voice or FSK components.

13 NOISE BLANKER SWITCH [NB] (p. 9)

Turns the noise blanker function on to remove pulse-type noise such as engine ignition noise.

- "NB" appears when the function is turned on.

14 AGC OFF SWITCH [AGC] (p. 9)

Deactivates the AGC function to receive weak signals blocked by strong adjacent signals.

- "~~AGC~~" appears when the [AGC] switch is turned on (stands for AGC deactivated).

15 MODE SWITCH [MODE]

Selects an operating mode temporarily. Available modes differ with version.

- USB, AM, J2B (AFSK), FSK, R3E and CW modes are available.
- The temporary mode is cleared and the previous mode appears when changing a channel.

16 TRANSMIT FREQUENCY SWITCH [TX FREQ]

(p. 8)

Displays the transmit frequency and opens the squelch to check and monitor the transmit frequency.

17 2182 kHz SELECTION SWITCH

[2182kHz • RESET] (p. iii)

- ➔ Selects channel 0 (2182 kHz; distress call frequency).

- The channel selector does not function when selecting channel 0.

- ➔ Ignores external control and gives the front panel control priority when an external controller (NMEA format) is connected.

18 ALARM SWITCH [ALARM] (p. iii)

- ➔ Emits a distress alarm signal from the speaker.

- ➔ Transmits a distress alarm or alarm testing signal when pushed together with the [TX FREQ] switch.

NOTE: General versions are not equipped with this [ALARM] switch.

*These keys function in some versions. See the separate *KEYPAD OPERATION* and *CHANNEL LIST* instruction sheet for operating details.

■ Display

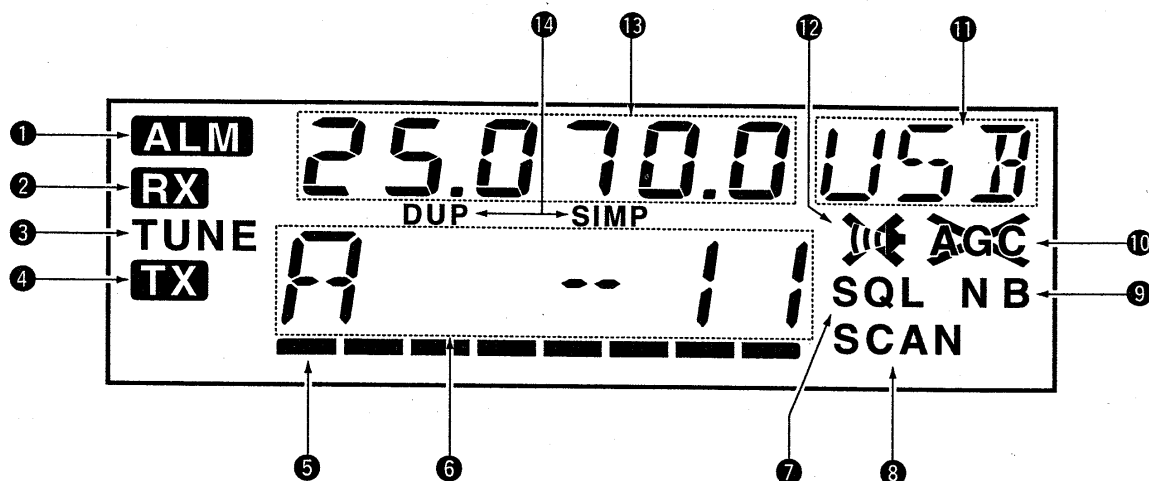

① ALARM INDICATOR (p. iii)

Appears when the alarm function is activated such as for an alarm test or distress alarm transmission.

- Not available in General version.

② RECEIVE INDICATOR

Appears while receiving and when the squelch is open.

③ TUNE INDICATOR (p. 8)

Flashes while the connected antenna tuner, such as Icom's AT-130, is being tuned.

- Tuning starts when transmitting on a new frequency or pushing the [TUNE] switch.

④ TRANSMIT INDICATOR

Appears when transmitting.

⑤ S/R F METER

- ➔ Shows the relative received signal strength while receiving.
- ➔ Shows output power while transmitting.

⑥ CHANNEL/VFO INDICATOR (p. 5)

- ➔ Shows the selected group and channel in memory mode.
- ➔ "FREQ" appears in VFO mode.

⑦ SQUELCH INDICATOR (p. 9)

Appears when the squelch is on.

⑧ SCAN INDICATOR (p. 6)

Appears when the scan function is in use.

- The scan function is not available on some versions.
- Pushing [SCAN] starts and stops scan.

⑨ NOISE BLANKER INDICATOR (p. 9)

Appears when the [NB] switch is turned on.

⑩ AGC OFF INDICATOR (p. 9)

Appears when the [AGC] switch is pushed to indicate the AGC function is deactivated.

⑪ MODE READOUT

Shows the selected operating mode (type of emission).

⑫ SPEAKER OFF INDICATOR

Appears when the [SPEAKER] switch is pushed to indicate the front panel speaker is deactivated.

⑬ FREQUENCY READOUT

- ➔ Shows the selected frequency whether in memory mode or VFO mode. (p. 5)
- ➔ Shows the transmit frequency (for duplex channels) when transmitting or when pushing [TX FREQ]. (p. 8)

⑭ SIMPLEX/DUPLEX INDICATORS

These appear to show whether the selected channel is simplex or duplex.

- In VFO mode, only simplex channels are available.
- No indicator means that there is no transmit frequency programmed.

Memory mode/VFO mode

The transceiver has 2 operating modes: *memory mode* and *VFO mode*. Memory mode is used to select pre-programmed marine channels in one of the 3 channel groups; VFO mode is used to select frequencies around preprogrammed channels.

Push [CH/FREQ] to toggle between memory and VFO modes.

- "FREQ" appears when in VFO mode.
- In VFO mode only simplex operation is possible.

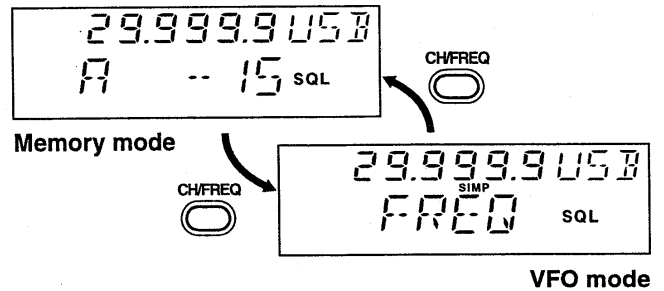

Selecting a channel

The transceiver has 150 channels divided into 3 groups of 50 (max.) channels. However, the number of channels in each group can be restricted in set mode (pgs. 13, 14) depending on your needs.

NOTE: When channel 0 and/or 2182 kHz is selected with the [2182KHz] switch, channel selection is NOT possible. In such cases, push [2182KHz] in advance.

- ① Push [CH/FREQ] to select memory mode, if necessary.
- ② Rotate the [GROUP] selector to select the desired channel group; then rotate the [CHANNEL] selector to select the desired channel.

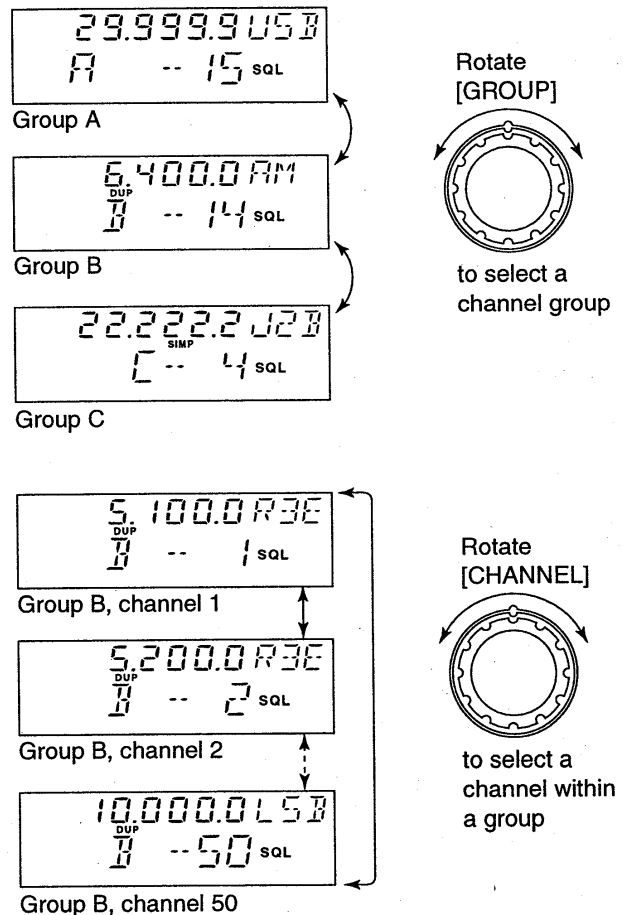

3 SELECTING A CHANNEL

◇ Scan function

The scan function allows you to automatically search channels within a group for signals. There are 2 scan types (selectable in set mode) as follows:

Channel scan

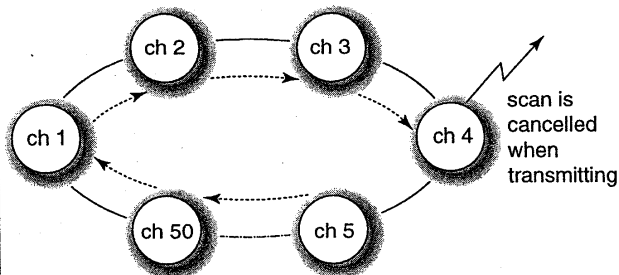

Channel resume scan

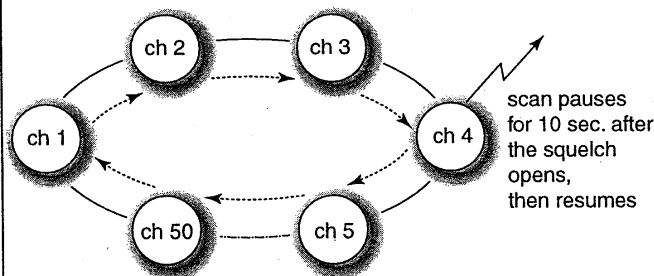

Scan operation

- ① Rotate the [GROUP] selector to select the group you wish to scan.
- ② Push [SQL] to close the squelch if necessary.
 - "SQL" appears.
- ③ Push [SCAN] to start scanning.
 - "SCAN" appears.
- ④ Push [SCAN] again to stop scanning.
 - "SCAN" disappears.

■ Selecting a frequency

The transceiver has 0.5 to 30.0 MHz general coverage receive capability with 100 Hz resolution. Use VFO mode to select frequencies around the preprogrammed channels in memory mode.

NOTE: Frequencies selected in VFO mode are for temporary use and are not stored in memory.

- ① While in memory mode, rotate the [GROUP] and [CHANNEL] selectors to select the channel nearest the frequency you want.
- ② Push [CH/FREQ] to select VFO mode.
 - "FREQ" appears.
- ③ Rotate the [CHANNEL] selector to select the desired frequency.
 - Frequency changes in 100 Hz steps.

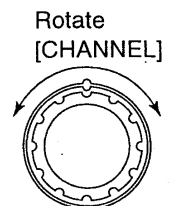
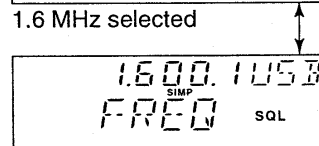
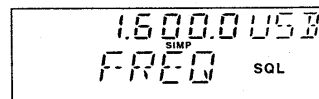

to select a frequency in 0.1 kHz steps

■ Resetting the CPU

Under some circumstances the transceiver's internal CPU may cause erroneous indications on the display. If this happens, reset the CPU as follows:

While pushing [ENT] + [0], push [POWER] to turn power on.

- The CPU is reset and the display at right appears.

 **CAUTION:** Resetting the CPU returns set mode contents to their default values.



Group A, channel 1 is selected after resetting the CPU.

Basic voice receive and transmit

- ① Check the following in advance:
- Microphone is connected.
 - [SPEAKER] switch is turned off.
 - [SQL] switch is turned off.
 - [CLARITY] control is set to the center position.
 - Memory mode is selected.
 - Push [CH/FREQ] to select memory mode, if necessary.

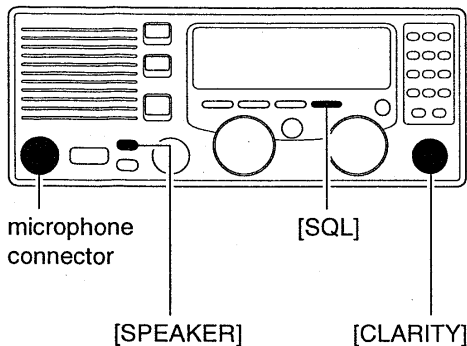

- ② Select the desired channel to be received with the [GROUP] and [CHANNEL] selectors.
- When receiving a signal, the S-meter shows the signal strength.
- ③ Adjust [VOLUME] to the desired audio level when receiving a signal.
- ④ Push [MODE] to select the desired operating mode, if the received signal is in a different mode.
- ⑤ Push [TUNE] to tune the antenna tuner, if connected.
- This operation is not necessary when "automatic tuning" is selected in set mode (p. 11).
- ⑥ To transmit on the channel, push and hold the PTT switch on the microphone.
- "TUNE" flashes for 1 to 2 sec. for the first transmission on a channel when an antenna tuner is connected.
- ⑦ After the flashing stops, speak into the microphone at your normal voice level.
- The RF meter shows the output power according to your voice level.
- ⑧ Release the PTT switch to return to receive.

Functions for transmit

◇ Transmit frequency check

When "DUP" appears on the display such as for a ship-to-shore channel, the transmit frequency differs from the receive frequency.

In such cases, the transmit frequency should be monitored before transmitting to prevent interference to other stations.

Push and hold [TX FREQ] to monitor the transmit frequency.

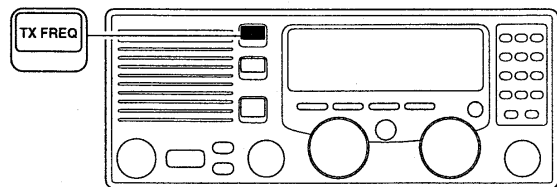

- The display shows the transmit frequency.

■ Functions for receive

◇ Squelch function

The squelch function detects signals with voice components and squelches (mutes) unwanted signals such as unmodulated beat signals. This provides quiet standby.

When you need to receive weak signals, the squelch should be turned off.

Push [SQL] to toggle the function on and off.

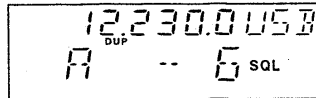

- "SQL" appears when the squelch function is turned on.

◇ Noise blanker

The noise blanker function reduces pulse type noise such as that coming from engine ignitions.

The noise blanker may distort reception of strong signals. In such cases, the noise blanker should be turned off.

Push [NB] to toggle the function on and off.

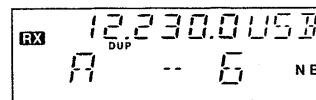

- "NB" appears when the noise blanker function is turned on.

◇ AGC off function

The receiver gain is automatically adjusted according to received signal strength with the AGC (Automatic Gain Control) function to prevent distortion from strong signals and to obtain a constant output level.

When receiving weak signals with adjacent strong signals or noise, the AGC function may reduce the sensitivity. In this situation, the AGC function should be deactivated.

Push [AGC] to toggle the function on and off.

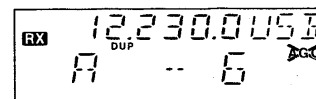

- "AGC" appears when the AGC function is deactivated.

◇ Clarity control

Voice signals received from other stations may be difficult to receive. This may sometimes happen if a station is transmitting slightly off frequency. In such cases, compensate the receive frequency only, using the [CLARITY] control.

Adjust [CLARITY] to improve the audio signal.

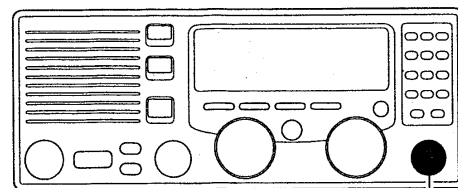

[CLARITY]

■ CW operation

The transceiver has the following CW keying features selectable in set mode as described on page 12.

- Full break-in (receiving is possible while transmitting)
- Delay keying (automatic transmission with keying)
- Off (manual transmission is necessary before keying)

- ① Connect a CW keyer or an external electronic keyer to the ACC(1) socket as shown at right.
- ② Select the desired channel to operate CW mode.
- ③ When the selected channel is not in CW mode, push [MODE] one or more times to select "CW."
- ④ Operate the CW keyer to transmit a CW signal.

NOTE:

- CW mode is not available in some versions.
- CW narrow can be selected in set mode (p. 12) when an optional filter is installed.

CW key connection

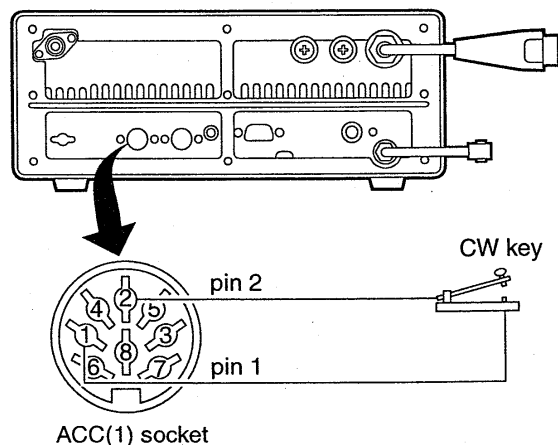

■ FSK operation

The transceiver has FSK and J2B modes for FSK operation—use FSK when using the built-in oscillator; use J2B when using an AFSK terminal unit.

- ① Connect an FSK terminal unit as shown at right.
- ② Select the desired channel.
 - FSK channels are available depending on version.
- ③ Push [MODE] one or more times to select the type of emission, "FSK" or "J2B."
- ④ Operate the FSK terminal unit.

NOTE:

- FSK shift frequency and FSK polarity can be adjusted in set mode (p. 12).
- Some transceivers may operate 1.7 kHz higher than the IC-M700PRO's J2B mode even when the same displayed frequencies are in use.

FSK terminal unit connection

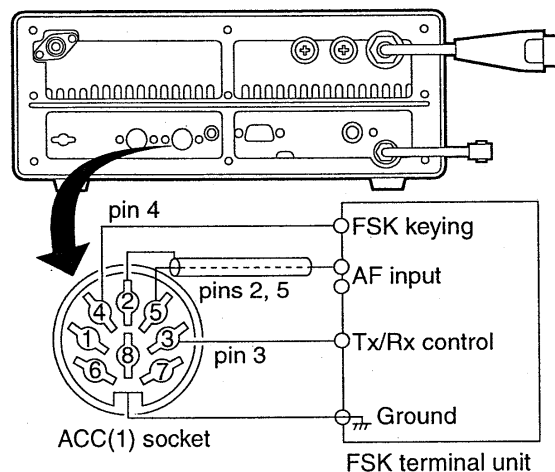

■ Set mode operation

Set mode operation is used for programming infrequently changed values or conditions of functions.

🔊 **NOTE:** Some of the set mode items described in this section are not available on some transceiver versions.

- ① Push [POWER] to turn power off, if necessary.
- ② While pushing [ENT] + [1], push [POWER] to turn power on and enter set mode.
- ③ Rotate the [GROUP] selector to select the desired item.
- ④ Rotate the [CHANNEL] selector to set the values or conditions for the selected item.
- ⑤ Turn power off and on again to exit set mode.

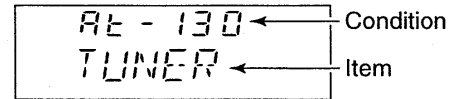
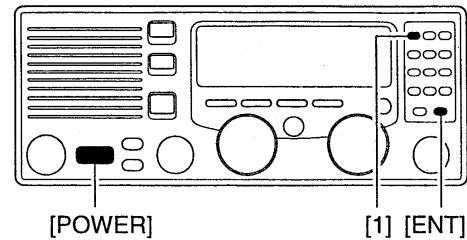

■ Set mode contents

<p>(1) Connected antenna tuner</p> <p>The transceiver has several tuner control systems for use with an optional Icom antenna tuner. Select the condition depending on the connected antenna tuner.</p> <p>🔊 NOTE: Internal switch selection may be required when using a non-Icom tuner (p. 19).</p>	<table border="0"> <tr> <td style="border: 1px solid black; padding: 5px; text-align: center;">AT-130 TUNER</td> <td style="padding-left: 10px;">AT-130 (default)</td> </tr> <tr> <td style="border: 1px solid black; padding: 5px; text-align: center;">AT-120 TUNER</td> <td style="padding-left: 10px;">AT-120</td> </tr> <tr> <td style="border: 1px solid black; padding: 5px; text-align: center;">AH-3 TUNER</td> <td style="padding-left: 10px;">AH-3</td> </tr> </table>	AT-130 TUNER	AT-130 (default)	AT-120 TUNER	AT-120	AH-3 TUNER	AH-3
AT-130 TUNER	AT-130 (default)						
AT-120 TUNER	AT-120						
AH-3 TUNER	AH-3						
<p>(2) Automatic tuning condition</p> <p>When the optional AT-130 automatic antenna tuner is connected, tuning can be started automatically without the [TUNE] switch, for instant operation.</p> <p>If manual tuning is required, this automatic operation can be deactivated.</p>	<table border="0"> <tr> <td style="border: 1px solid black; padding: 5px; text-align: center;">ON AT-TUN</td> <td style="padding-left: 10px;">Tuning starts when pushing [PTT] on a new frequency.</td> </tr> <tr> <td style="border: 1px solid black; padding: 5px; text-align: center;">OFF AT-TUN</td> <td style="padding-left: 10px;">Tuning starts only when [TUNE] is pushed. (default)</td> </tr> </table>	ON AT-TUN	Tuning starts when pushing [PTT] on a new frequency.	OFF AT-TUN	Tuning starts only when [TUNE] is pushed. (default)		
ON AT-TUN	Tuning starts when pushing [PTT] on a new frequency.						
OFF AT-TUN	Tuning starts only when [TUNE] is pushed. (default)						
<p>(3) Scan type selection</p> <p>This item sets scan to function as "channel scan" or "channel resume scan."</p> <p>Both channel scan and channel resume scan search around a user selected channel or search in the band when a channel is selected.</p>	<table border="0"> <tr> <td style="border: 1px solid black; padding: 5px; text-align: center;">CH SC-TYP</td> <td style="padding-left: 10px;"><i>Channel scan</i> Scan is canceled when transmitting.</td> </tr> <tr> <td style="border: 1px solid black; padding: 5px; text-align: center;">CH-RES SC-TYP</td> <td style="padding-left: 10px;"><i>Channel resume scan</i> Scan pauses when squelch opens, then resumes after 10 sec. (default)</td> </tr> </table>	CH SC-TYP	<i>Channel scan</i> Scan is canceled when transmitting.	CH-RES SC-TYP	<i>Channel resume scan</i> Scan pauses when squelch opens, then resumes after 10 sec. (default)		
CH SC-TYP	<i>Channel scan</i> Scan is canceled when transmitting.						
CH-RES SC-TYP	<i>Channel resume scan</i> Scan pauses when squelch opens, then resumes after 10 sec. (default)						

5 SET MODE

(4) Scan speed

Selects scan speed as follows:

(unit: sec./ch)

2	3	4	5	6	7	8	9	10
2	3	4	5	6	7	8	9	10

Faster

Slower

2
SC--SPT

Fastest scan speed
(default)

10
SC--SPT

Slowest scan speed

(5) CW/FSK narrow filter

This item selects the passband width for CW (A1A), FSK or J2B mode.

NOTE: When "on" is selected without optional filter installation, the transceiver does not function in these modes.

OFF
NR--FIL

Passband:
2.3 kHz/-6 dB
(default)

ON
NR--FIL

Passband:
500 Hz/-6 dB

(6) FSK shift frequency

Several shift frequencies (the difference between the mark and space frequency) are used for FSK operation. This item allows you to select a shift frequency for almost any FSK system.

170
FK--SFT

Shift frequency:
170 Hz
(default)

425
FK--SFT

Shift frequency:
425 Hz

850
FK--SFT

Shift frequency:
850 Hz

(7) FSK polarity

Normal and reverse polarities are available for FSK operation. This item allows you to select one of these polarities.

"FK-REV off" (normal):
key open (mark); key close (space)

"FK-REV on" (reverse):
key open (space); key close (mark)

OFF
FK--REV

FSK normal
(default)

ON
FK--REV

FSK reverse

(8) CW break-in

The CW break-in function (in A1A mode) toggles transmit and receive with CW keying. Full break-in allows you to receive signals between transmitted keying pulses during CW transmission. Semi break-in allows you to mute receiving until keying stops with some delay time.

FULL
CW--BK

Full break-in
Automatic keying without
delay time (default)

DELAY
CW--BK

Semi break-in
Automatic keying with delay
time

OFF
CW--BK

OFF
Manual transmission
necessary for keying

(9) LCD contrast

The LCD contrast can be adjusted through 10 levels to suit transceiver mounting angle, location and ambient lighting.

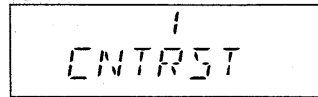

Lowest contrast

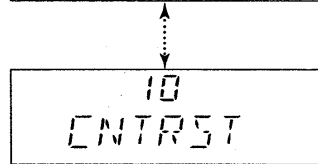

(default: 7)

Highest contrast

(10) ID number setting for remote control

When connecting an external controller such as a personal computer, 2-digit ID codes are required to access the transceiver. The IC-M700PRO adopts NMEA0183 format and uses a "proprietary sentence" for remote control.

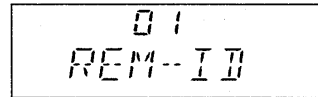

NMEA ID: 1

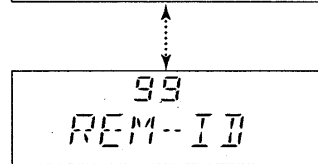

(default: 2)

NMEA ID: 99

(11) Remote control input terminal

Remote control signals can be input via the [REMOTE] socket or [CLONE] jack.

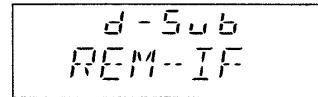

[REMOTE] socket
(default)

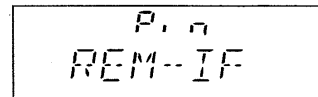

[CLONE] jack

(12) Display backlighting

Allows you to select 1 of 4 intensity levels for the display backlighting.

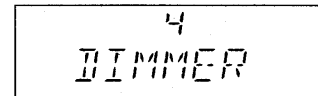

Dimmest
(default)

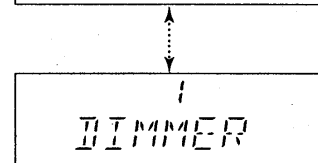

Brightest

(13) Group A channel inhibit

This item allow you to set the number of usable channels in channel group A, up to a maximum of 50 channels.

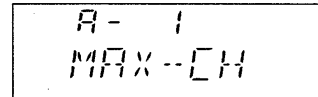

Minimum number of
channels set for
Group A: 1

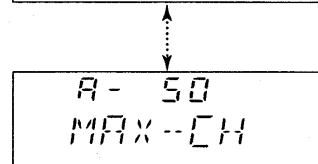

Maximum number of
channels set for
Group A: 50 (default)

5 SET MODE

(14) Group B channel inhibit

This item allow you to set the number of usable channels in channel group B, up to a maximum of 50 channels.

b - 1
MAX--CH

Minimum number of channels set for Group B: 1

b - 50
MAX--CH

Maximum number of channels set for Group B: 50 (default)

(15) Group C channel inhibit

This item allow you to set the number of usable channels in channel group C, up to a maximum of 50 channels.

c - 1
MAX--CH

Minimum number of channels set for Group C: 1

c - 50
MAX--CH

Maximum number of channels set for Group C: 50 (default)

■ Connections on rear panel

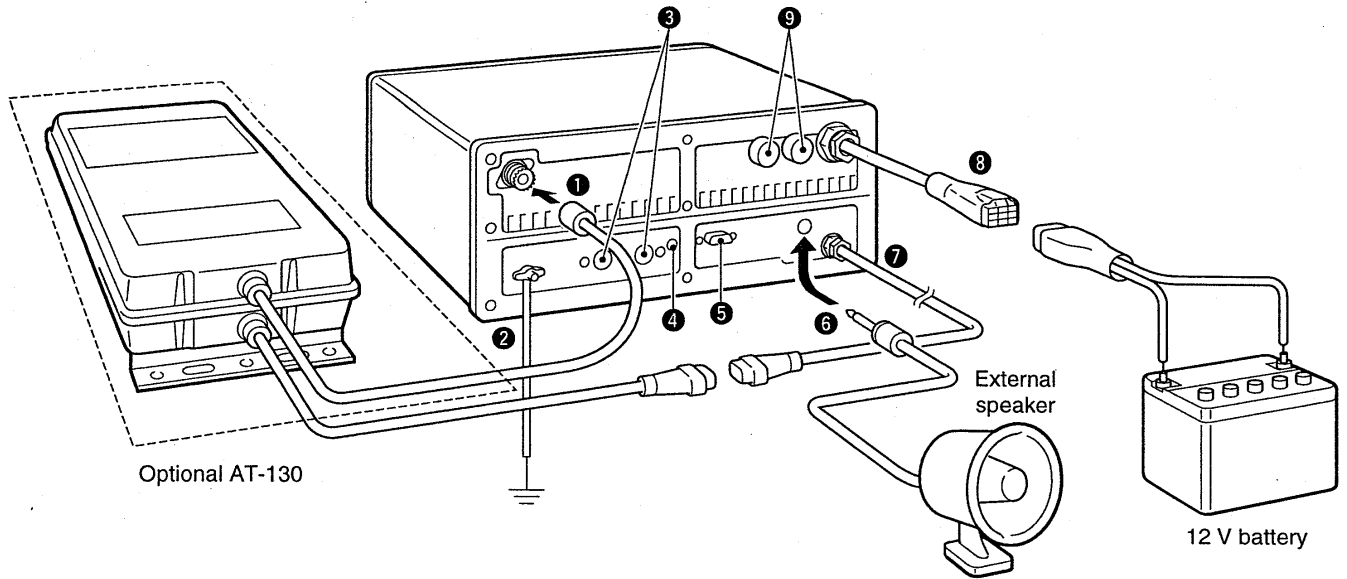

❶ ANTENNA CONNECTOR (p. 19)

Connects a 50 Ω HF band antenna with a 50 Ω matched coaxial cable and a PL-259 plug.

❷ GROUND TERMINAL

IMPORTANT! Connects a ship's (or vehicle's) ground. See p. 18 for details.

❸ ACC(1) and ACC(2) SOCKETS

See p. 16 for details.

❹ CLONE JACK

For Dealer use only.

❺ REMOTE SOCKET (p. 17)

REMOTE socket for Marine and General versions.

❻ EXTERNAL SPEAKER JACK

Connects a 4–16 Ω external speaker using a ¼" monaural plug. This external audio is not muted by the [SPEAKER] switch on the front panel.

❼ TUNER RECEPTACLE

Connects a control cable to an optional AT-130 ANTENNA TUNER. A female connector is supplied for connection.

❽ DC POWER RECEPTACLE

Connects to a regulated 12–16 V DC power source such as a 12 V battery or DC power supply using the supplied DC power cable.

▼ CAUTION: DO NOT connect to a 24 V battery. This will damage the transceiver.

❾ FUSE HOLDERS

Hold two 30 A fuses for +ve and –ve terminals. Replace both fuses when one fuse is blown.

■ Unpacking

Microphone (EM-101)	1
Microphone hanger	1
DC power cable (OPC-568)	1
Mounting bracket	1
Bracket knobs (8820000170)	4

CONNECTORS

DIN connector (8-pin for ACC1)	1
DIN connector (7-pin for ACC2)	1
Speaker plug (5610000040)	1
Tuner connector (56100000150)	1
Pins for tuner connector (6510019030)	4

NUTS AND BOLTS

Allen bolt (M6 × 50)	4
Self-tapping screws (M6 × 30)	4
Nuts (M6; use 2 pcs. for each bolt)	8
Flat washers (M6)	8
Spring washers (M6)	4
Self-tapping screws (3.5 × 30 for mic. hanger)	2

FUSES

FGB 30 A (rear panel)	2
FGB 5 A (internal)	2

■ Connector information

ACC(1)	PIN	PIN NAME	DESCRIPTION	SPECIFICATIONS
	1	CWK	CW and FSK keying input.	Input level: Less than 0.6 V for transmit.
	2	GND	Connects to ground.	Connected in parallel with ACC(2) pin 2.
	3	SEND	Input/output pin. Goes to ground when transmitting. When grounded, transmits.	Ground level: -0.5 to 0.8 V Input current: Less than 20 mA Connected in parallel with ACC(2) pin 3.
	4	MOD	Modulator input. Usable when pin 3 is grounded.	Input impedance: 10 kΩ Input level: Approx. 100 mV rms
	5	AF	AF detector output. Fixed, regardless of [AF] position.	Output impedance: 4.7 kΩ Output level: 100-300 mV rms
	6	NC	No connection.	
	7	13.6 V	13.6 V output when power is on.	Output current: Max. 1 A Connected in parallel with ACC(2) pin 7.
	8	ALC	ALC voltage input.	Control voltage: -3 to 0 V Input impedance: More than 10 kΩ Connected in parallel with ACC(2) pin 5.

ACC(2)	PIN	PIN NAME	DESCRIPTION	SPECIFICATIONS
	1	8 V	Regulated 8 V output.	Output voltage: 8 V ±0.3 V Output current: Less than 10 mA
	2	GND	Same as ACC(1) pin 2.	
	3	SEND	Same as ACC(1) pin 3.	
	4	NC	No connection.	
	5	ALC	Same as ACC(1) pin 8.	
	6	RLC	T/R relay control output.	When transmitting: 0 V (less than 0.5 A)
	7	13.6 V	Same as ACC(1) pin 7.	

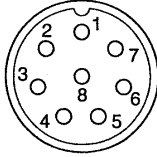
MICROPHONE	PIN	PIN NAME	DESCRIPTION	SPECIFICATIONS
	1	MIC+	Audio input from the microphone element.	Input impedance: 600 Ω
	2	NC	No connection.	
	3	AF1	AF output controlled with [VOLUME]. Connected to pin 4 in the microphone.	Output impedance: 4 Ω
	4	AF2	AF input. Connected to pin 3 in the microphone.	
	5	PTT	PTT switch input.	When grounded, transmits.
	6	GND	Connected to ground.	
	7	MIC-	Coaxial ground for MIC+.	
	8	AF-	Coaxial ground for AF1 and AF2.	

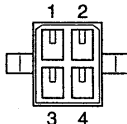
TUNER	PIN	PIN NAME	DESCRIPTION	SPECIFICATIONS
	1	KEY	Key signal input.	-0.5-0.8 V during tuning
	2	START	Start signal output.	Pulled up 8 V, 0 V(100 msec) as start signal.
	3	13.6V	13.6 V output	Max. current: 2 A
	4	E ANTC	-ve terminal Antenna current input	For USA version Input level: Approx. 2 Vrms (Europe version)

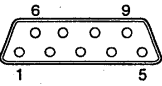
REMOTE	PIN	PIN NAME	DESCRIPTION	SPECIFICATIONS
	1	MOD+	Modulation input from an external terminal unit.	Input impedance: 600 Ω Input level: Approx. 1.3 mV rms
	2	MOD-	Coaxial ground for MOD+.	
	3	AF+	AF detector output for an external terminal unit.	Output impedance: 600 Ω Output level: 0.25–2.5 V rms
	4	AF-	Coaxial ground for AF+.	
	5	NMI+	NMEA data input.	NMEA standard format/level
	6	NMI-	Coaxial ground for NMI+.	
	7	NMO+	NMEA data output.	NMEA standard format/level
	8	NMO-	Coaxial ground for NMO+.	
	9	GND	Ground for digital equipment.	

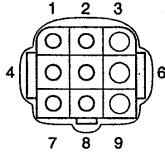
DC 13.6V	PIN	PIN NAME	DESCRIPTION	SPECIFICATIONS
	1,4,7	+ve	+ve DC input	Max. power consumption: 30 A
	2,5,8	-ve	-ve DC input	

Ground connection

The transceiver and antenna tuner MUST have an adequate ground connection. Otherwise, the overall efficiency of the transceiver and antenna tuner installation will be reduced. Electrolysis, electrical shocks and interference from other equipment could also occur.

For best results, use the heaviest gauge wire or strap available and make the connection as short as possible. Ground the transceiver and antenna tuner to one ground point, otherwise voltage differences between 2 ground points may cause electrolysis.

▼ **CAUTION:** The IC-M700PRO has a negative ground. NEVER connect the IC-M700PRO to a "plus-grounding ship," otherwise the transceiver will not function.

Ground system example

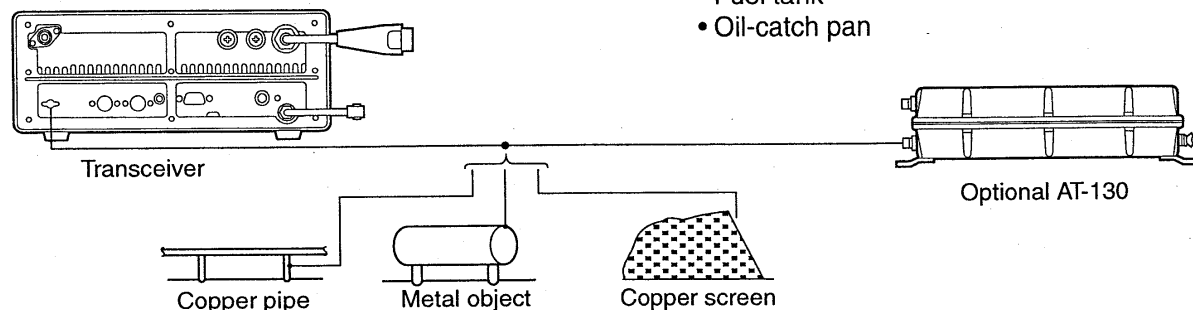

Good ground points

- Ship's ground terminal
- External ground plate
- External copper screen

Acceptable ground points

- Stainless steel tuna tower
- Stainless steel stanchion
- Through mast
- Through hull
- Metal water tank

Undesirable ground points

(these points may cause electrolysis)

- Engine block
- Keel bolt

Unusable ground points

(these connections may cause an explosion or electrical shock)

- Gas or electrical pipe
- Fuel tank
- Oil-catch pan

Power source

The transceiver requires regulated DC power of 13.6 V and at least 30 A. There are 3 ways to supply power:

- Direct connection to a 12 V battery in your ship through the supplied DC power cable.
- Use the PS-60 DC POWER SUPPLY to connect to an AC outlet.
- Use the PS-66 DC-DC CONVERTER to connect to a 19–32 V DC power source.

▼ **CAUTION:** The supplied DC power cable MUST be used to provide power to the transceiver. AVOID exceeding the 3 m (10 ft) length of the DC power cable. If it is necessary to make a run of over 3 m, use #6 or similar weight cable instead of the supplied DC power cable for a maximum run of 6 m (20 ft).

DC power cable connection

NOTE: Use terminals for the cable connection.

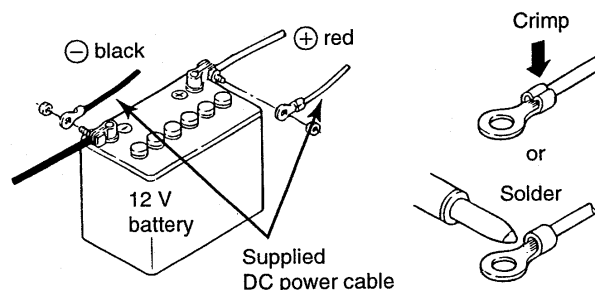

Antenna

Most stations operate with a whip or long wire (insulated backstay) antenna. However, these antennas cannot be connected directly to the transceiver since their impedance may not be matched with the transceiver antenna connector.

With a 50 Ω matched antenna all marine bands cannot be used. The following antenna matcher or antenna tuner may be helpful for antenna installation.

◇ MN-100/MN-100L ANTENNA MATCHERS

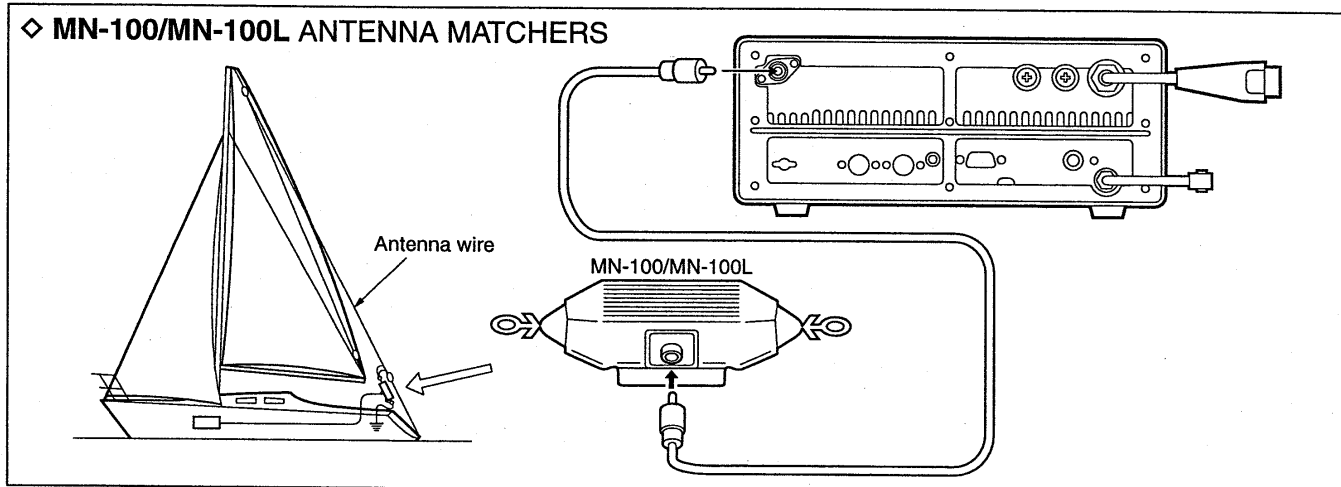

◇ AT-130 AUTOMATIC ANTENNA TUNER

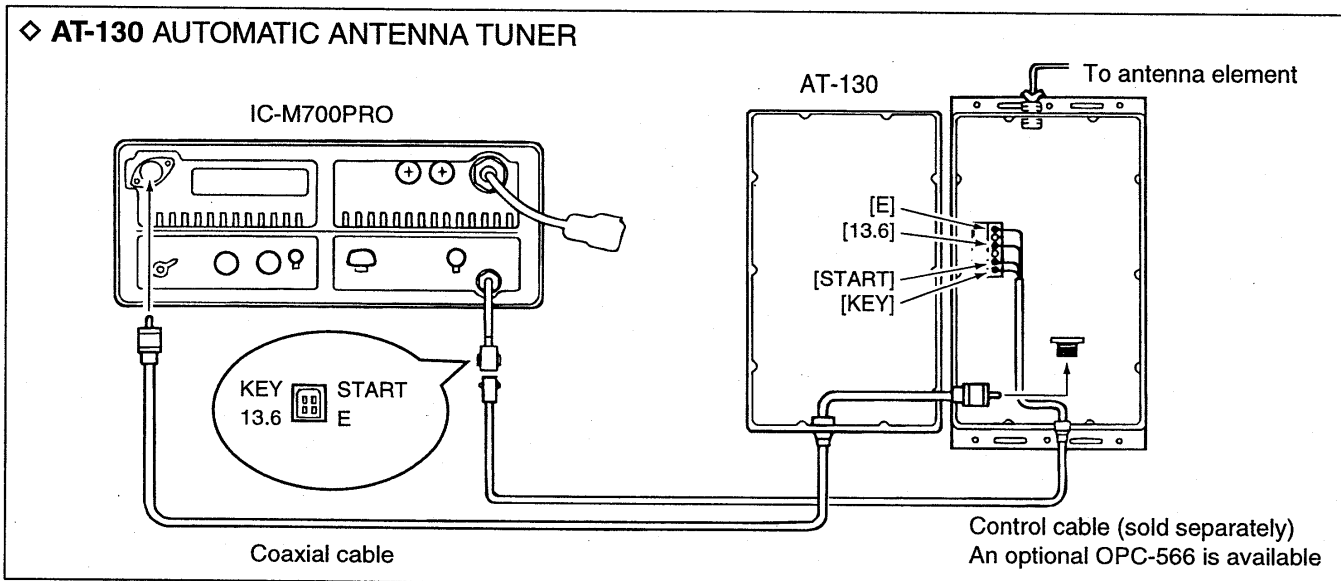

◇ Non-Icom tuner

Some non-Icom tuners may be used with the IC-M700PRO. Please consult your dealer or marina if you wish to connect one. The following internal settings may be required for connection.

Supplies 8 V when pushing [TUNE].



S9
(Start port level)

Grounded when pushing [TUNE].
(used for AT-130—default)

Accepts "LOW" as an answer back signal.



S11
(Key port input)

Accepts "HIGH" as an answer back signal.
(used for AT-130—default)

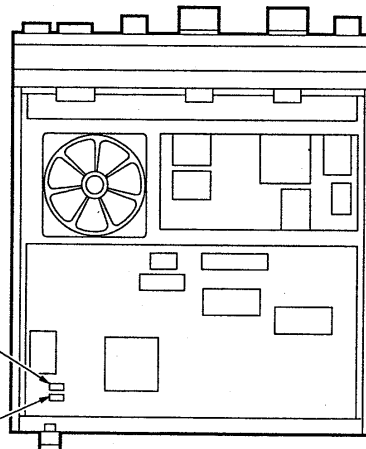

■ Mounting

▼ **WARNING: NEVER** mount the transceiver overhead. The weight of the transceiver is approximately 8 kg., but its apparent weight will increase several fold due to wave shocks or vibration. The transceiver must be mounted on a flat, hard surface.

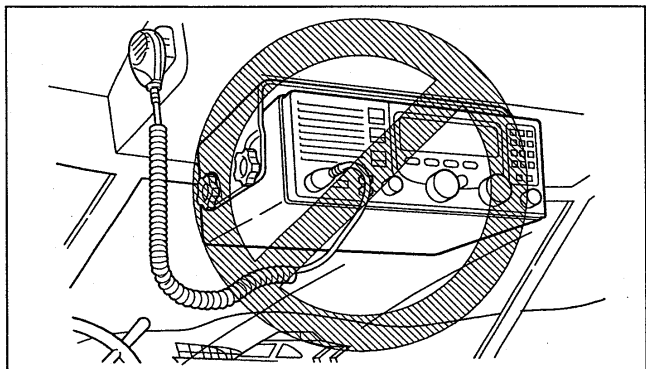

◇ Mounting location

Select a location that provides easy access to the front panel for navigation safety, has good ventilation and is not subject to sea spray. The face of the transceiver should be at 90 degrees to your line of sight when operating it.

▼ **CAUTION: KEEP** the transceiver and microphone at least 1 meter away from your vessel's magnetic navigation compass.

Check the installation angle; the display may not be easy to read at some angles.

◇ Mounting example

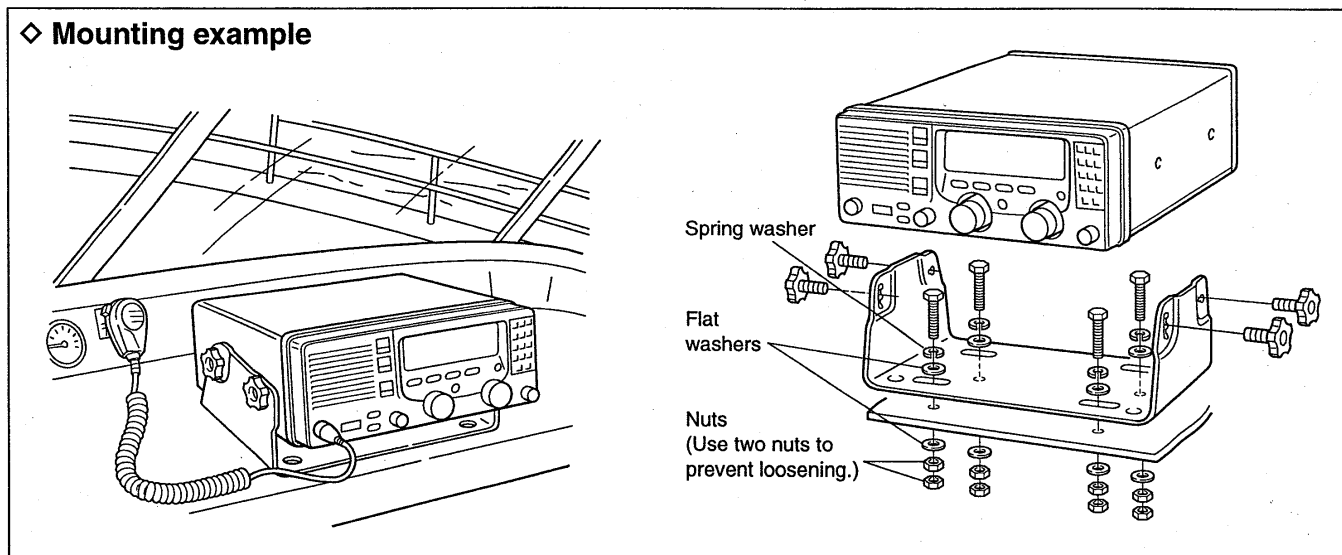

◇ Transceiver dimensions

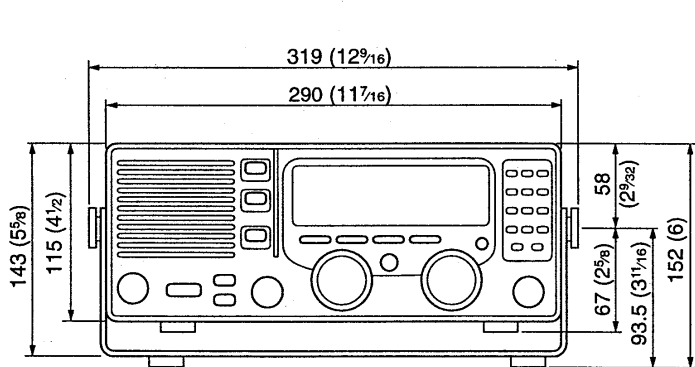

Unit : mm (inches)

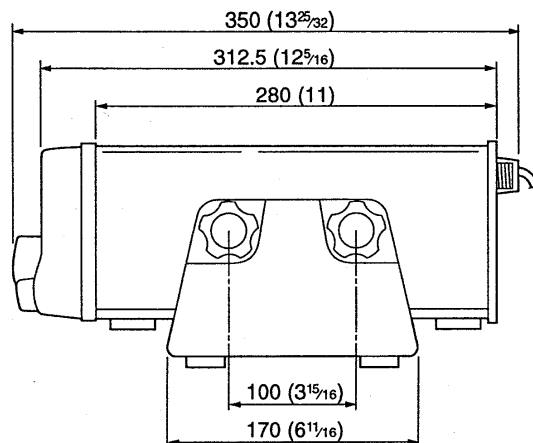

■ Installing internal options

◇ Opening the case

Follow the case and cover opening procedures shown here when you want to install an option or adjust a setting for non-Icom tuner control.

- ① Remove the 9 screws from the rear panel, then remove the rear frame and rear sealing.
- ② Remove the transceiver case.
- ③ When reassembling the transceiver, check the following points:
 - ➡ Internal fan and slits in the case are on the same side.
 - ➡ Front sealing is mated correctly.
 - ➡ Rear sealing is attached in the proper orientation.
 - ➡ Screws are tightened securely.

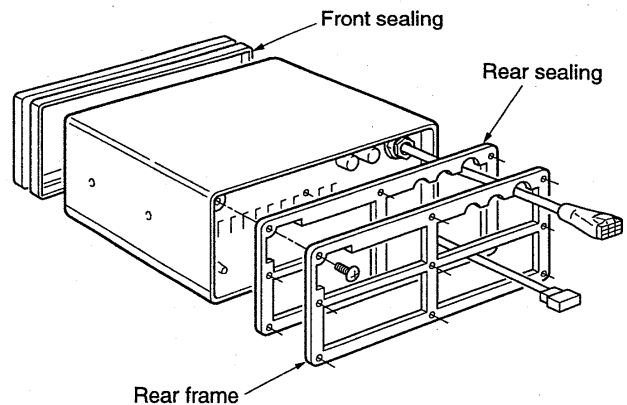

◇ Installing an optional filter and alarm unit

After opening the case as shown above, install the desired option to the position as at right. These options are available (or already built-in) for the following versions:

Version	Marine	General
FL-100 CW/FSK NARROW FILTER	optional	optional
UT-95 2-TONE ALARM UNIT	built-in	optional

After installing the 2-tone alarm unit into a General version, remove the plastic cover on the [ALARM] switch to use the switch.

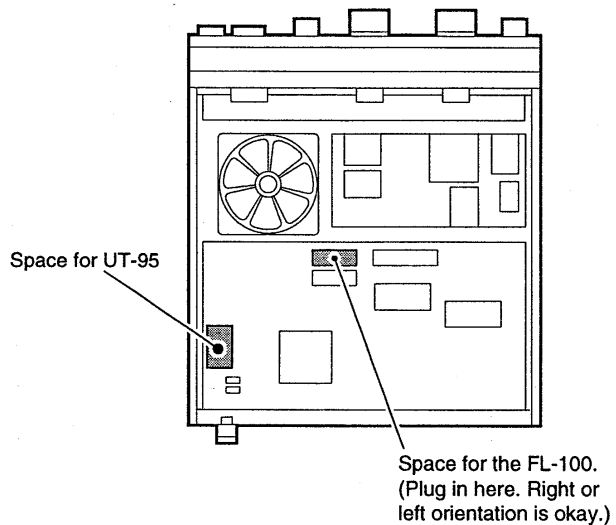

■ Fuse replacement

The transceiver has 3 fuses to protect internal circuitry, 2 fuses for the fuse holder on the rear panel and 1 for inside. If the transceiver stops functioning, check the fuses below.

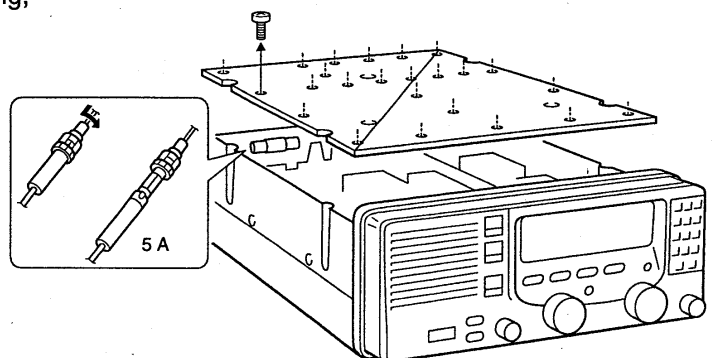
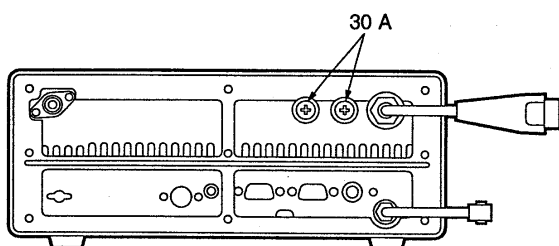

What appears to be equipment malfunction may not be damaging or difficult to solve. Check the following chart before making any adjustments or sending the transceiver to an Icom Service Center.

	PROBLEM	POSSIBLE CAUSE	SOLUTION	REF.
POWER	Power does not come on when [POWER] is pushed.	<ul style="list-style-type: none"> • Power cable is improperly connected. • Blown fuse. 	<ul style="list-style-type: none"> • Reconnect the cable securely. • Check for cause, then replace the fuse with a spare one. 	p. 18 p. 21
	No sound comes from the speaker.	<ul style="list-style-type: none"> • The [SPEAKER] switch is turned on. • Microphone is not connected. • The squelch is closed. 	<ul style="list-style-type: none"> • Turn off the [SPEAKER] switch. • Connect the microphone to the [MICROPHONE] connector. • Push the [SQL] switch to turn the squelch off. 	p. 2 p. 2 p. 9
RECEIVE	Sensitivity is too low and only strong signals are audible.	<ul style="list-style-type: none"> • Antenna is not properly matched to the operating frequency. • Wrong tuner condition is selected in set mode. 	<ul style="list-style-type: none"> • Push [TUNE] to tune the connected antenna tuner or select "automatic tuning" using set mode when an optional AT-130 is connected. • Set the proper condition for the connected tuner. 	pgs. 2, 11 p. 11
	Received audio is unclear or distorted.	<ul style="list-style-type: none"> • Wrong type of emission is selected. • AGC is deactivated while receiving a strong signal. • Noise blanker is turned on when receiving a strong signal. • The [CLARITY] control is rotated too far clockwise or counterclockwise. 	<ul style="list-style-type: none"> • Push [MODE] to select the proper operating mode. • Push [AGC] to activate the AGC function. • Push [NB] to turn the noise blanker off. • Adjust the [CLARITY] control to receive proper audio output. 	p. 3 p. 9 p. 9 p. 9
TRANSMIT	Your signal does not reach as far away as usual.	<ul style="list-style-type: none"> • Antenna tuner is improperly matched to the operating frequency when manual tuning is selected. • CW or FSK mode is selected for voice transmission. 	<ul style="list-style-type: none"> • Push [TUNE] to tune the connected antenna tuner or select "automatic tuning" using set mode. • Push [MODE] to select USB mode (or AM, R3E, etc.). 	pgs. 2, 11 p. 3
	Transmit signal is unclear or distorted.	<ul style="list-style-type: none"> • Wrong type of emission is selected. • Microphone is too close to your mouth. 	<ul style="list-style-type: none"> • Push [MODE] to select the proper operating mode. • Speak into the microphone naturally and do not hold the microphone too close to your mouth. 	p. 3 —
DISPLAY	All indicators appear and the channel number cannot be read.	<ul style="list-style-type: none"> • The highest contrast is selected in set mode. 	<ul style="list-style-type: none"> • Set to the proper display contrast. 	p. 13

■ Specifications

GENERAL

- Frequency coverage:

Receive	500 kHz–29.999 MHz	
Transmit	1.6– 2.9999 MHz	4.0– 4.9999 MHz
	6.0– 6.9999 MHz	8.0– 8.9999 MHz
	12.0– 13.9999 MHz	16.0–17.9999 MHz
	18.0– 19.9999 MHz	22.0–22.9999 MHz
	25.0– 27.5000 MHz	
- Mode: USB, AM, CW, FSK and AFSK
(available modes differ with version)
- Number of channels: 150 channels (max.)—3 groups of 50 channels each
- Antenna impedance: 50 Ω nominal
- Usable temp. range: -30°C to $+60^{\circ}\text{C}$ (-22°F to $+140^{\circ}\text{F}$)
- Frequency stability: ± 10 Hz (-30°C to $+60^{\circ}\text{C}$; -22°F to $+140^{\circ}\text{F}$)
(± 20 Hz above 15 MHz for General and Marine versions)
- Power supply requirement: 13.6 V DC $\pm 15\%$
(negative and floating grounds available depending on version)
- Current drain:

Transmit (max. output power)	30 A
Receive (max. audio output)	2.5 A (negative ground)
- Dimensions: 291.4(W) \times 116.4(H) \times 315(D) mm
11.3(W) \times 4.4(H) \times 12.8(D) in
- Weight: 7.9 kg; 17.4 lb (negative ground)

TRANSMITTER

- Output power: 150 W PEP (60 W above 24 MHz)
- Spurious emissions: -75 dB typical
- Carrier suppression: 65 dB typical
- Unwanted sideband suppression: 70 dB typical
- Microphone impedance: 600 Ω

RECEIVER

- Sensitivity

USB, CW, AFSK, FSK, (for 12 dB SINAD):	0.35 μV typical (1.8–29.9999 MHz)
	1.0 μV (1.6–1.7999 MHz)
	6.3 μV (0.5–1.5999 MHz)
AM (for 10 dB S/N):	2.2 μV typical (1.8–29.9999 MHz)
	6.3 μV (1.6–1.7999 MHz)
	32 μV (0.5–1.5999 MHz)
- Spurious response rejection: 80 dB typical (1.6–29.9999 MHz)
- Audio output power: 5.0 W (at 10% distortion with a 4 Ω load)
- Audio impedance: 4 to 8 Ω
- Clarity variable range: ± 150 Hz

All stated specifications are subject to change without notice or obligation.

■ Options

AT-130 AUTOMATIC ANTENNA TUNER



Matches the transceiver to a long wire antenna with a minimum of insertion loss.

MN-100 ANTENNA MATCHER

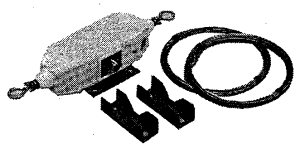

Matches the transceiver to a dipole antenna. Covers all HF bands from 1.5 to 30 MHz. 8 m \times 2 antenna wires come attached.

MN-100L ANTENNA MATCHER

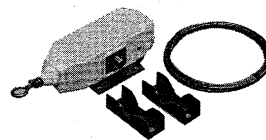

Matches the transceiver to a long wire antenna. Covers all HF bands from 1.5 to 30 MHz. 15 m \times 1 antenna wire comes attached.

HS-50 HANDSET

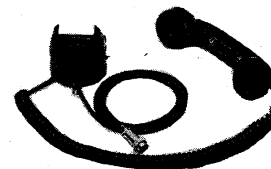

Provides better audio reception during offshore conditions and comes in handy for listening privacy on board.

PS-60 DC POWER SUPPLY

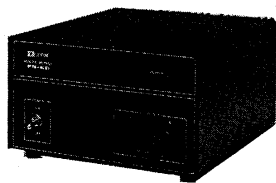

Provides 13.6 V DC (30 A) output from an AC outlet.

PS-66 DC-DC CONVERTER

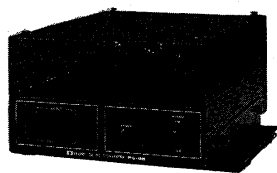

Provides 13.6 V DC (30 A) output from a 19–32 V DC power source.

FL-100 CW/FSK NARROW FILTER

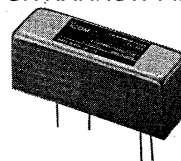

Allows better receiver selectivity for CW and FSK. Bandwidth: 500 Hz/–6 dB

UT-95 2-TONE ALARM UNIT

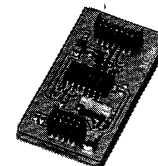

Provides an alarm transmission for emergency use during maritime operation.

Count on us!

